

Pivo Maxi

LED Downlight

Versatile

Cutout Size  Ø 190mm

HIGH CRI >90Ra
FASHION modules
FOOD modules

AVAILABLE ON REQUEST







Up to **40W**
Power

Up to **5879lm**
Lumen

3000K
4000K
CCT



Product Information	LED Power	24W		40W	
	CRI	>80Ra			
	CCT	3000K	4000K	3000K	4000K
	LED Lumen	3432lm	3571lm	5574lm	5879lm
	LED Efficacy	143lm/W	148lm/W	139lm/W	147lm/W
	LOR	Up to 80%			
	Driver	Non-Dimmable Driver (included)			
	Reflector				
		18°	24°	36° included	60°

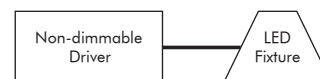

System includes: fixture and driver

On Request	Article No.	Description	Article No.	Description
	5.14.0134	Reflector 18° for LED spot Pivo Maxi	-	Dimmable driver available on request
	5.14.0135	Reflector 24° for LED Spot Pivo Maxi		
	5.14.0137	Reflector 60° for LED Spot Pivo Maxi		

Pivo Maxi 3000K

H [m]	[lux]	Beam [Ø cm]	Field [Ø cm]
1	5689	70	140
2	1422	130	280
3	632	200	420
4	356	260	560
5	228	330	700

Beam (50%) Angle: 36° Field (10%) Angle: 70°

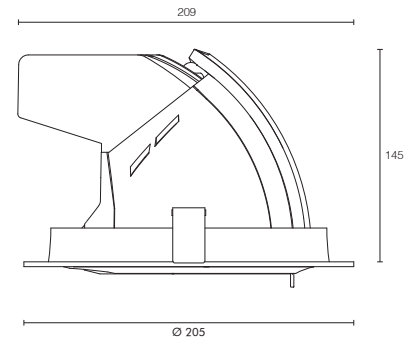
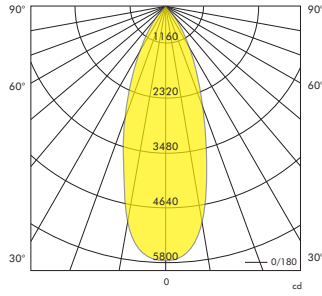

Article No.	Product Name	Color	LED Lumen	CCT	CRI	Cooling	LED Power	Reflector	Cutout Size
2.11.1714	LED spot Pivo Maxi	Grey	3432lm	3000K	>80Ra	Passive	24W	36°	Ø 190mm
2.11.1715	LED spot Pivo Maxi	White	3432lm	3000K	>80Ra	Passive	24W	36°	Ø 190mm
2.11.1716	LED spot Pivo Maxi	Black	3432lm	3000K	>80Ra	Passive	24W	36°	Ø 190mm
2.11.1717	LED spot Pivo Maxi	Grey	3571lm	4000K	>80Ra	Passive	24W	36°	Ø 190mm
2.11.1718	LED spot Pivo Maxi	White	3571lm	4000K	>80Ra	Passive	24W	36°	Ø 190mm
2.11.1719	LED spot Pivo Maxi	Black	3571lm	4000K	>80Ra	Passive	24W	36°	Ø 190mm
2.11.1720	LED spot Pivo Maxi	Grey	5574lm	3000K	>80Ra	Passive	40W	36°	Ø 190mm
2.11.1721	LED spot Pivo Maxi	White	5574lm	3000K	>80Ra	Passive	40W	36°	Ø 190mm
2.11.1722	LED spot Pivo Maxi	Black	5574lm	3000K	>80Ra	Passive	40W	36°	Ø 190mm
2.11.1723	LED spot Pivo Maxi	Grey	5879lm	4000K	>80Ra	Passive	40W	36°	Ø 190mm
2.11.1724	LED spot Pivo Maxi	White	5879lm	4000K	>80Ra	Passive	40W	36°	Ø 190mm
2.11.1725	LED spot Pivo Maxi	Black	5879lm	4000K	>80Ra	Passive	40W	36°	Ø 190mm